

## ARS14系列

### 性能参数

- 环境温度：-40℃~70℃
- 额定电流：10A
- 卡簧：ARS-H14A, ARS-H14C, ARS-H14D
- 插入式模块：有
- 剥露导线长度：7mm
- 适用继电器型号：ARP14F系列
- 额定电压：250VAC
- 介质耐压min.：2000VAC(输入输出间)
- 标识卡：有
- 螺钉扭矩：0.6Nm
- 最大导线范围：1×4/2×2.5mm<sup>2</sup>

### 型号注释

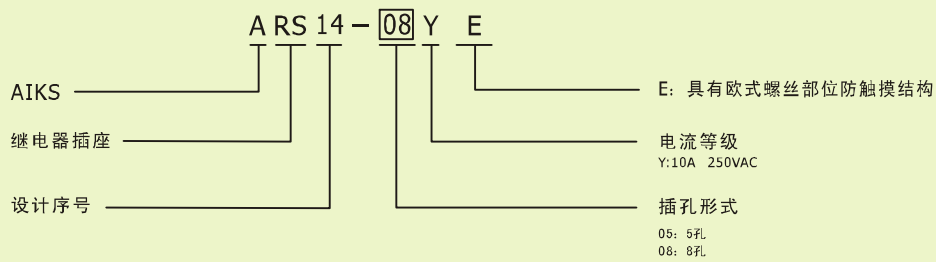

### 外形图, 接线图, 安装尺寸图

单位: mm

ARS14-05YE



外形图

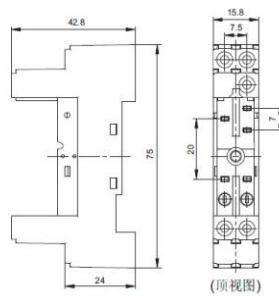

接线图

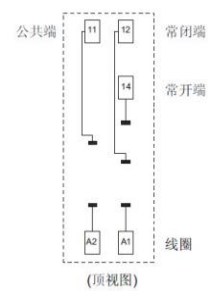

ARS14-08YE

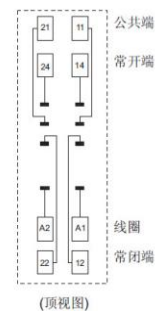
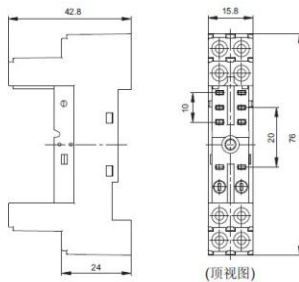

▶ 配套卡簧尺寸

单位: mm

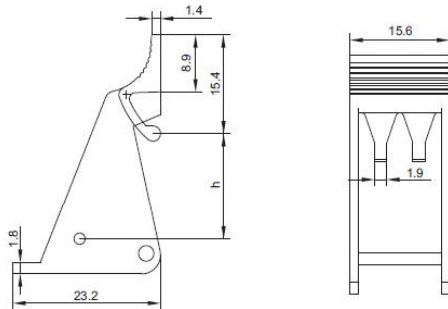

注H有三种规格:

- ARS-H14A:h=16mm(适用于-1型)
- ARS-H14C:h=21mm(适用于-2型)
- ARS-H14D:h=26mm(适用于-3型)

▶ 表示卡尺寸、跨接片尺寸

单位: mm

标识卡尺寸

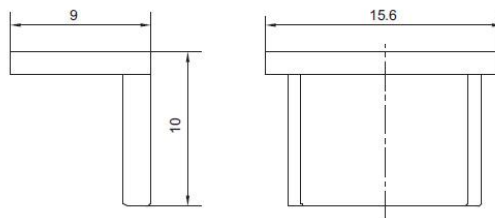

跨接片尺寸

